

solve for (x)futurisms

a design brief

Peter Lunenfeld, Denise Gonzales Crisp, and the students of UCLA DESMA 104, Spring 2021 - March 23, 2023

• critical design • design pedagogy • bespoke futures • design research • afro futurism • latinx futurism • indigenous futurism
• sino futurism • critical race theory

The United States of America went through a radical self-examination in 2020. The shock of the Covid pandemic combined with economic and social dislocations, followed by the police murder of George Floyd, forced a reckoning on race, racism, and state violence. That same year, Opal Tometi, a co-founder of Black Lives Matter, wrote that she believes “that what we are witnessing now is the opening up of imaginations, where people are beginning to think more expansively about what the solutions could be¹.”

In the Design Media Arts department at UCLA, I teach a course titled Design Futures, that has historically been an incubator for hybrid research and production. In response to the issues of the moment, we look to investigate how design theory and praxis could open up a series of new, more inclusive futures.

This contribution was published on www.able-journal.org in a story.able format:

www.able-journal.org/solve-for-xfuturisms

Images are displayed inline in a grid. Optional text can be added beneath each image.

The question before us was: what can design do to help us through this moment? How could we conceive or design futures that we actually want to live in, rather than as briefs from commercial interests? We determined one answer to a series of design research provocations, that we termed Solve for (x)Futurisms. These ran the gamut from Afro Futurisms to Latinx Futurisms, Indigenous Futurisms to Queer Futurisms. The group researched extant practices, modeled design ethnographies, and then mocked up their own bespoke future scenarios.

What follows is a visual primer of the (x) Futurisms of a small group of young makers on the edge of the Pacific Ocean in a year that was definitively in and of the 21st century.

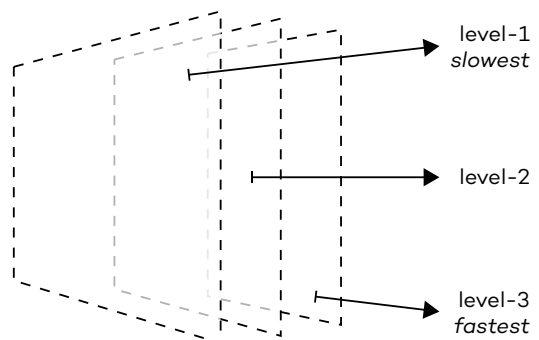

1. Isaac Chotiner, “A Black Lives Matter Co-Founder Explains Why This Time Is Different,” The New Yorker, June 3, 2020. <https://newyorker.com/news/q-and-a/a-black-lives-matter-co-founder-explains-why-this-time-is-different>

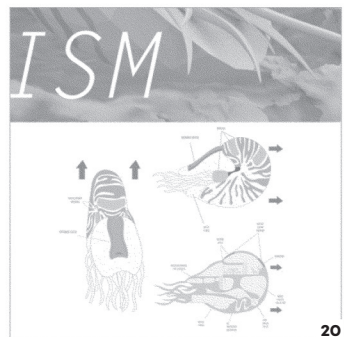
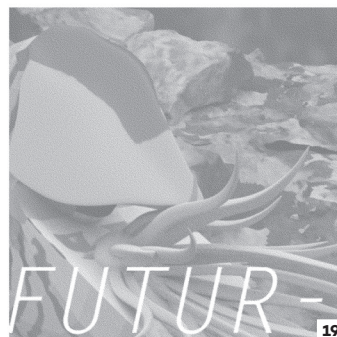
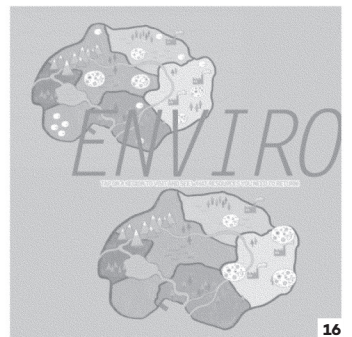
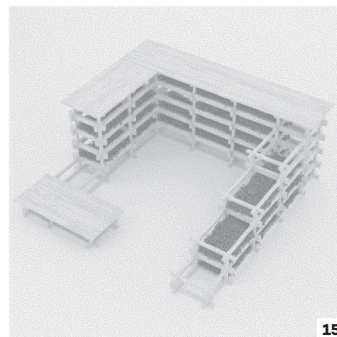
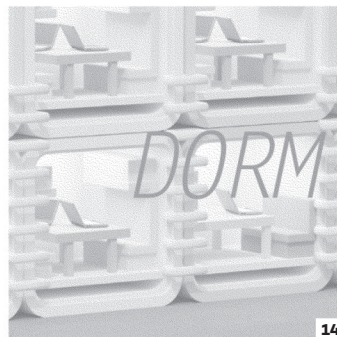
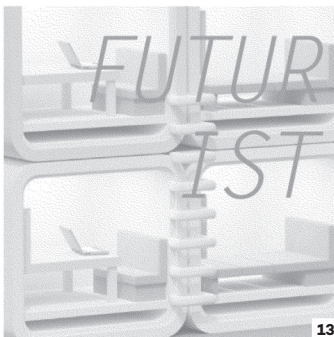
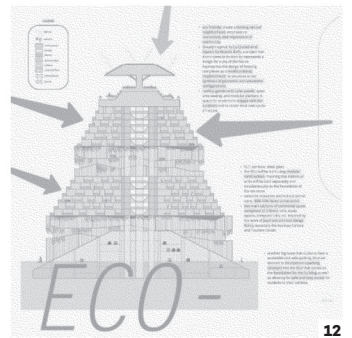
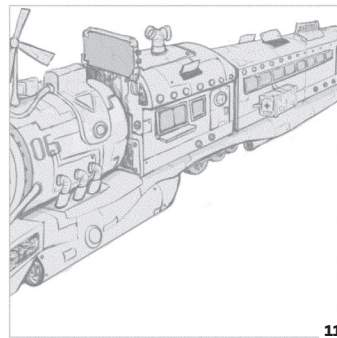
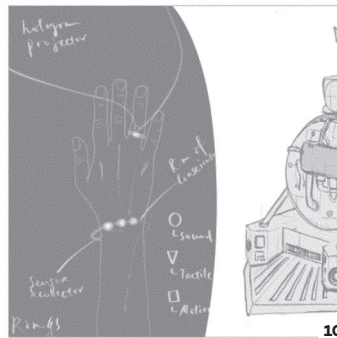
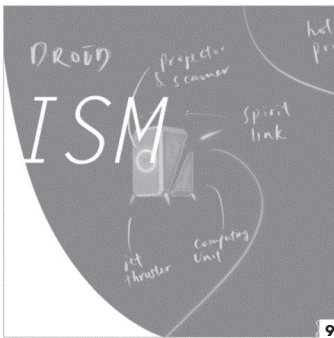
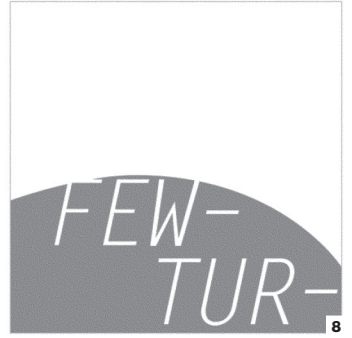
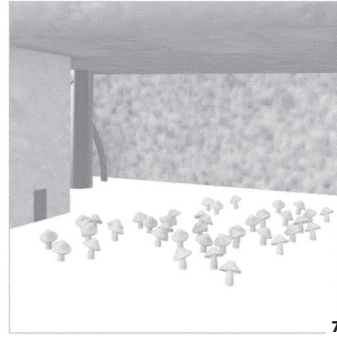
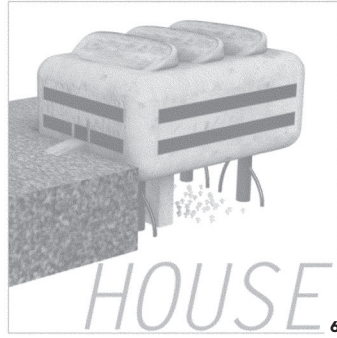
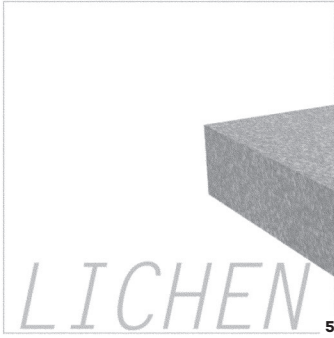
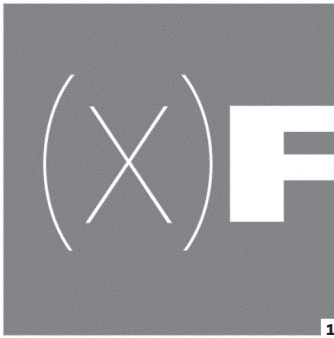

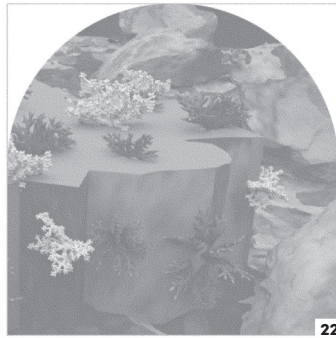
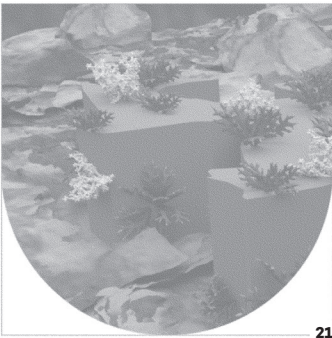

SYM
BIO
TICA

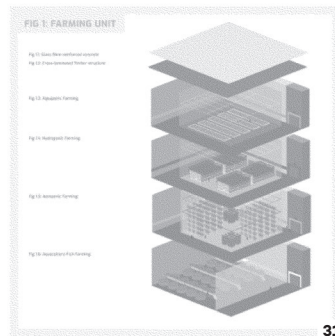
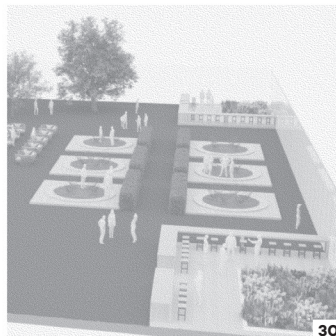
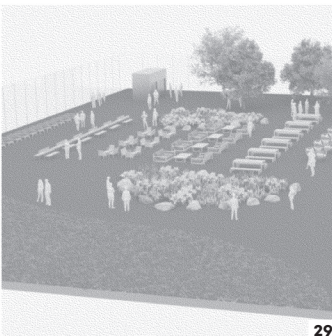
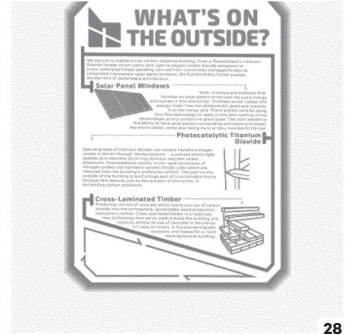
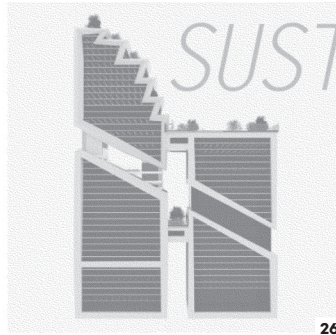
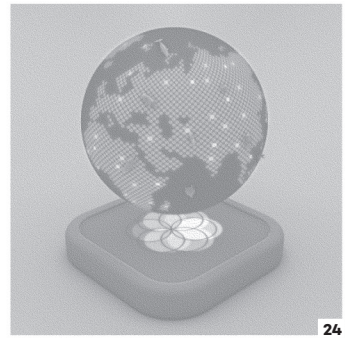
23

MOVEMENT
FOR
A UNITED

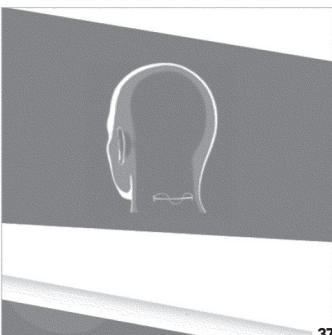
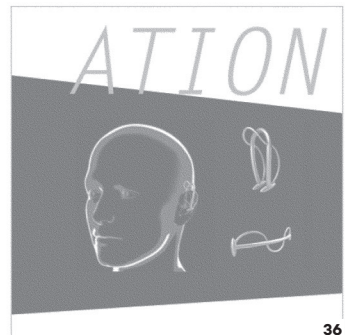
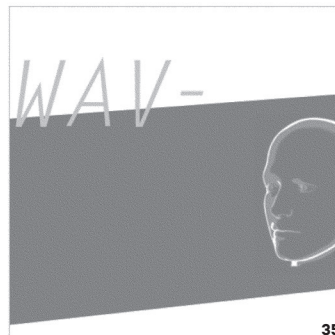
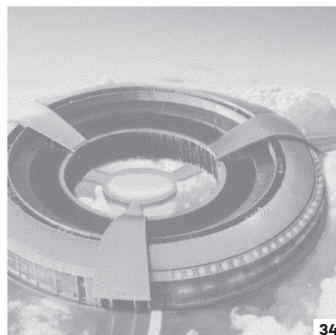
32

(X)FUTURISMS
Peter Lunenfeld
Denise Gonzales Crisp
2022

39

image captions

- 1.** Can design transcend its roots in “commercial art” and emerge as a methodology for general improvement rather than branding and finish? In other words, how could we conceive or design futures that we actually want to live in, rather than as briefs from commercial interests?
- 2.** One approach we explored at UCLA in 2020 concerned what’s been called “x Futurisms.” The class offered a mix of lectures, seminars, and studios, and the final result was a series of design research provocations we termed Solve for (x)Futurisms.
- 3.** These ran the gamut from Afro Futurisms to Latinx Futurisms, Indigenous Futurisms to Queer Futurisms. The students did design ethnographies, broke into teams, and then mocked up their own bespoke future scenarios.
- 4.** Working in teams, they crafted artifacts, images, objects, models, scenarios, comix, illustrations, animations, games, and even ghosts, following Anthony Dunne and Fiona Raby’s determination to think “through design rather than through words.”
- 5.** *Lichen House* provides trauma processing and creative development in marginalized communities, combining technology, ancient healing modalities, and indigenous medicine as a way to reconnect people to themselves and the land in order to heal their communities and beyond.
- 6.** Self-healing concrete is the product of collaborations with microbiologist and is made with safe bacteria that produces limestone to seal cracks and fissures.
- 7.** The subterranean fungi garden is supported by the buildings renewable waste system. Species include nutrient rich edible and psychoactive psilocybin for microdosing.
- 8.** This group concentrated on simultaneously reducing consumption while increasing experience, which they termed “Fewturism.”
- 9.** *Fewturism*: a self-sustaining society that embraces wandering with purpose, a community with a low desire for material goods, focused on experiencing life with spirituality.
- 10.** Anyone can enter at any part of the train they want and can leave at any station. Their room key enables them to be taken in by the community. There are identity symbols similar to an ID card, bracelets with charms or add-ons representing all they have done while on the train.
- 11.** The train carries the community, circumnavigating the world. Community members volunteer to take turns in positions of production, service, and consumption, as the rest of the population is able to focus on enjoyment, experience, and spirituality.
- 12.** The ecoFuturist Dormitory unit houses undergraduate college students sustainably. The communal space pods, roof garden, and reworked floorplans envision future affordances for student populations with flexible needs and schedules.
- 13.** Study pods—smaller than conventional dorm rooms—isolate against noise and create a space to sleep and study. The beds convert into a desk and a bench, and students can sign up by the hour across campus.
- 14.** The rethought layout of living spaces offers extra privacy, while at the same time encouraging collaboration. The balconies extend the room and serve as an extra border.
- 15.** Modular planters, made from reclaimed wood, using recycled wastewater, and featuring native plantings, allow residents to contribute to communal gardens requiring minimal maintenance.
- 16.** *Greedy Sheep* is a game devised to encourage a future in which environmental justice has been obtained and the damages of environmental racism have been reversed. Discover risk and justice as you give back to communities and nurture your sheep to perfection.
- 17.** The interface concepts reflect the way capitalism exploits and oppresses people to benefit the rich and powerful. The white wool parallels the predominance of whiteness in environmental decisions that disregard communities of color, subjecting them to mass amounts of pollution and climate change effects.
- 18.** Deep sea ocean exploration is necessary and inevitable; it is key to expanding our knowledge, improving our technologies, and ensuring our survival. This is *Aqua-Futurism*, speculative designs of deep-sea exploration technology based on biomimicry: “OUR FUTURE HAS A FUTURE”.
- 19.** Hyperosmotic wetsuits draw oxygen from the water, which diffuses through the membranes of the tentacles creating a form of jet propulsion as well as replenishing the air supply. In the helmets, the mantis shrimp lenses process light at spectra five times broader than the human eye in air.
- 20.** The *Nautilus* allows for a nondisruptive movement through the deep sea, while collecting microplastics along the way. It has multiple viewing areas and works in tandem with the wetsuit to optimize exploration.
- 21.** The Home Station is a deep-sea reef base that serves as the home for the *Nautilus* and its crew.
- 22.** The Home Station also functions as a research lab to develop new technologies and discover new uses for microplastics.
- 23.** *Symbiotica* simulates real-life extinction scenarios, challenging players to collaborate on ways to save endangered species and create balance between humans, animals, and systems.
- 24.** The game implements a toys-to-life series of animal tokens that connect to the spherical game console, which itself resembles Earth and floats in physical space. The game combines elements of physical board gaming with virtual and hybrid media.
- 25.** Playing cards: during game play everyone on the same team works against an AI that is acting to eliminate biodiversity.
- 26.** *Sustainability Centers* should have been suggested, scheduled, designed, implemented, and constructed years before we were born. We envision every city on the globe linked to an interwoven network reaching from each city district to a centrally located ones.
- 27.** New urban, conceptually open-sourced, architectural domains from Los Angeles to Shanghai, Lagos, and Melbourne.
- 28.** As the framework gains traction, other cities will be compelled to construct their own, thus expediting the transition to sustainable urban practices.
- 29.** View of the Skypark. Far from a lone scheme, the Sustainability Center stands as a culturally adaptable, diverse, and purposefully interpretable framework.
- 30.** With a solution to the “X” and a client that is the future, the Sustainability Center model transforms how urban landscapes affect our natural environments and our planet.
- 31.** As designers, our obscurity is fed through our umbilical cord attached to the market. However, what if we design for the future itself? Not to seduce multinationals, but to cure our time-tethered tomorrow: what if the future itself was the client?
- 32.** To combat violence and confront the ecological crisis, the people of Earth have formed a single sovereign nation called *United Terra*.
- 33.** *United Terra*: a bright future where no human is illegal, and all human inhabitants of Earth are Terran citizens.
- 34.** The manifesto: “The people of Earth demand a united earth government where our differences are recognized and celebrated and nationalities no longer exclude us and separate us. The human race has become the Terran race and Earth is our home and protectorate. Let us unite Terra.”
- 35.** Inspired by the DeafSpace Project [hbhm architects & Gallaudet University], *Wavation* posits new ways of physically experiencing sound and music via integrated hardware and software. It does not aim to “fix” disability but rather make musical experiences that all can enjoy.
- 36.** *Wavation* features bendable, futuristic metal that can conform to an individual’s head.
- 37.** The bendability allows people to wear the device in different ways and adapt to any other devices that they are wearing, such as hearing aids.
- 38.** More than just listening. Experience the sound. Experience the waves.

credits

course conceptualization and organization: Peter Lunenfeld, Professor of Design Media Arts, UCLA

design and reconceptualization: Denise Gonzales Crisp, North Carolina State professor and designer, and Maya Lu, design intern at UCLA

student groups:

Lichen House: Omar Ababneh, Jessica Till, Arin Fazio, Jennifer Hotes, Haley Penn, and Kathleen Yang

Fewturism: Sihan Li, Chuyu Liu, Lala Luo, Qiao Li, Guo Chen

ecoFuturist Dormitory: Henry Barbera, Kaize Xie, Sejun Park, Amie Xu, Min Li, Kat Sung

Greedy Sheep: Sabrina Chang, Emily Kim, Rachel Kim, Fabian Rios, Serena Tie, and Charles Tran

Aqua-Futurism: Albert Acosta, Zara Aiken, Helena Alcalá, Nel Alpysbayeva, Sascha Barnes, and Natalia Beltran

Symbiotica: Nickolas Brogdon, Paige Brunson, Joanna Chen, Charlie Chica, and Peyton Gee

Sustainability Center: Eli Henriksen, Eun Seo Kang, Max Gruber, Christine Kao, and Chloe Kim

United Terra: Adam Lomeli, Collette Lee, Sophie Lin, Jane Lee, Justin Lee, and Ruth Lee

Wavation: Max Loy, Anika Murthy, Anton Nguyen, Aileen Oh, Hannah Oh, and Ashley Ong

graphic design and graphic transformation of images: Denise Gonzales Crisp

about the authors

Denise Gonzales Crisp is a graphic designer, writer, and Professor Emerita of Graphic Design at North Carolina State University College of Design. A topic she dubbed the “DecoRational,” defending and writing alternative design discourse, constitutes ongoing design research. She is the author of *Graphic Design in Context: Typography* (Thames & Hudson, 2012). She specializes in contextual thinking and contrary making.

Peter Lunenfeld (PhD) is professor and Vice Chair of UCLA’s Design Media Arts department and on the Digital Humanities and Urban Humanities faculties. Recent works include *City at the Edge of Forever: Los Angeles Reimagined* (Viking, 2020), *Digital_Humanities* (co-author, MIT, 2012), and *The Secret War Between Downloading and Uploading* (MIT, 2011).

<https://peterlunenfeld.com>

<https://penguinrandomhouse.com/books/600080/city-at-the-edge-of-forever-by-peter-lunenfeld/>

<https://dma.ucla.edu/>

rights and references

illustration rights and references

Lichen House, 2021, Omar Ababneh, Jessica Till, Arin Fazio, Jennifer Hotes, Haley Penn, Kathleen Yang.

Fewturism, 2021, Sihan Li, Chuyu Liu, Lala Luo, Qiao Li, Guo Chen.

ecoFuturist Dormitory, 2021, Henry Barbera, Kaize Xie, Sejun Park, Amie Xu, Min Li, Kat Sung.

Greedy Sheep, 2021, Sabrina Chang, Emily Kim, Rachel Kim, Fabian Rios, Serena Tie, & Charles Tran.

Aqua-Futurism, 2021, Albert Acosta, Zara Aiken, Helena Alcalá, Nel Alpysbayeva, Sascha Barnes, Natalia Beltran.

Symbiotica, 2021, Nickolas Brogdon, Paige Brunson, Joanna Chen, Charlie Chica, Peyton Gee.

Sustainability Center, 2021, Eli Henriksen, Eun Seo Kang, Max Gruber, Christine Kao, Chloe Kim.

United Terra, 2021, Adam Lomeli, Collette Lee, Sophie Lin, Jane Lee, Justin Lee, Ruth Lee

Wavation, 2021, Max Loy, Anika Murthy, Anton Nguyen, Aileen Oh, Hannah Oh, Ashley Ong.

Graphic design and graphic transformation of images by Denise Gonzales Crisp.

bibliography and references

Burdick, Anne. 2019. "Designing Futures from the Inside." *Special Issue: Design and Futures (Vol. I), Journal of Futures Studies* 23, no. 3.

Crisp, Denise Gonzales. 2003. "Towards a Definition of the Decorational." *Design Research: Methods and Perspectives*, ed. Brenda Laurel. Cambridge, MA: MIT Press.

Candy, Stuart and Kelly Kornet. 2019. "Turning Foresight Inside Out: An Introduction to Ethnographic Experiential Futures." *Special Issue: Design and Futures (Vol. I), Journal of Futures Studies* 23, no. 3.

Donohue, Micah. 2020. "Sci-Fi Ain't Nothing but Mojo Misspelled Latinx Futurism in Smoking Mirror Blues." *Chiricú Journal: Latina/o Literatures, Arts, and Cultures* 5, no. 1.

Heinrich, Ari, Howard Chiang, and Ta-wei Chi. 2020. "Toward a Queer Sinofuturism." *Screen Bodies* 5, issue 2.

Hogan, Ernest. 2001. "Stuck outside Tenochtitlán, with the Tezcatlipoca Blues." Excerpt from *Smoking Mirror Blues*. La Grande, OR: Wordcraft of Oregon.

Kilgore, De Witt Douglas. 2014. "Afrofuturism." *The Oxford Handbook of Science Fiction*, ed. Rob Latham. Oxford: Oxford University Press.

Lunenfeld, Peter. 2011. "Bespoke Futures." In *The Secret War Between Downloading and Uploading*. Cambridge, MA: MIT Press.

Lunenfeld, Peter. 2019. "The California Design Dominion." *Los Angeles Review of Books Quarterly*, no. 24: <https://lareviewofbooks.org/article/california-design-dominion-thirteen-propositions/>.

Lunenfeld, Peter. 2021. "Colloidal Suspension: Immersion and the Pedagogies of Making." Denise Gonzales Crisp. *Sensate Journal* (2021) <https://sensatejournal.com/colloidal-suspension-immersion-and-the-pedagogies-of-making/>.

Wallis, Keziah and Miriam Ross. 2020. "Fourth VR: Indigenous Virtual Reality Practice." *Convergence* 27, no. 2.

to cite this article

Lunenfeld, Peter, Denise Gonzales Crisp, and the Students of UCLA DESMA 104. 2023. "Solve for (x)Futurisms: A Design Brief." *able journal*. <https://able-journal.org/solve-for-xfuturisms>

MLA EN Lunenfeld, Peter, Denise Gonzales Crisp, and the Students of UCLA DESMA 104. "Solve for (x)Futurisms: A Design Brief." *able journal*, 2023. <https://able-journal.org/solve-for-xfuturisms>

ISO 690 EN LUNENFELD, Peter, CRISP, Denise Gonzales, and the Students of UCLA DESMA 104. Solve for (x)Futurisms: A Design Brief. *able journal* [online]. 2023. Available from: <https://able-journal.org/solve-for-xfuturisms>

APA EN Lunenfeld, P., Crisp, D. G., & the Students of UCLA DESMA 104 (2023). Solve for (x)Futurisms: A Design Brief. *able journal*. <https://able-journal.org/solve-for-xfuturisms>